

DALLA
CORTE

ICON

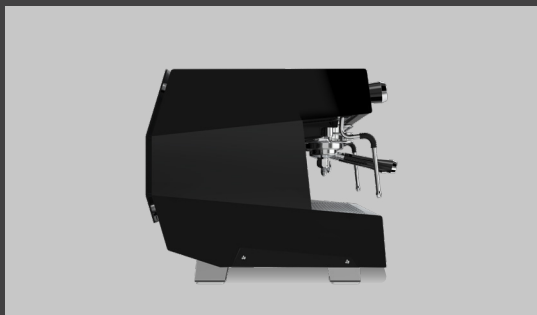

ICON - 2 GRUPPI

MAKE YOUR COFFEE ICONIC Icon è una macchina affidabile in grado di produrre un espresso eccellente e ripetibile nel tempo, la risposta a ciò di cui necessitano business con picchi di lavoro in ore di punta, per fornire risultati impeccabili con il minimo sforzo.

AFFIDATI AL DC SYSTEM Le tecnologie DC system GCS, MCS e OCS rendono Icon una candidata ideale per il canale Horeca, dove alti tassi di turnover e frequenti richieste durante la giornata possono mettere a dura prova la qualità in tazza.

YOUR BRAND, YOUR ICON Linee leggere e tagli geometrici per i pannelli laterali, formati da un unico guscio di acciaio inossidabile. Per il pannello posteriore, invece, ampio spazio alla vocazione custom, grazie a un ampio range di colori RAL e alla possibilità di utilizzare materiali speciali su misura.

dimensioni (l x h x p)	730x510x525 mm
peso	77 kg
consumo di energia (24h-stand-by)	4,5 kW (3,9kW 200-220V3)
potenza massima	380/400V3N +T 50/60 Hz - 220/230 V, 50/60 Hz - 200/220 V, 3 50/60 Hz
carico connesso	8 l
capacità della caldaia	0,5 l
capacità dei gruppi indipendenti	opzionale
GCS Grinder Control System	opzionale
MCS Milk Control System	opzionale

DALLA
CORTE

ICON

ICON - 2 GRUPPI

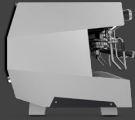

DYNAMIC BLACK
1-MC-ICON-2-DB-400

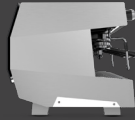

DYNAMIC WHITE
1-MC-ICON-2-DW-400



DYNAMIC RED
1-MC-ICON-2-DR-400



DYNAMIC GREY
1-MC-ICON-2-DG-400



BLACK WALNUT
1-MC-ICON-2-BN-400

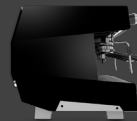

TOTAL MATT BLACK
1-MC-ICON-2-TMB-400



WHITE OAK
1-MC-ICON-2-WO-400



ADJUSTABLE FEET
(optional)



DOUBLE
MCS



DC SYSTEM

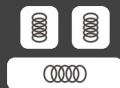

MULTIBOILER



COOL TOUCH
(optional)



ENERGY
SAVING



CUSTOM
COLOURS



CUSTOM
MATERIALS



58mm FILTER
(optional)

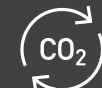

CO₂
CARBON
NEUTRAL

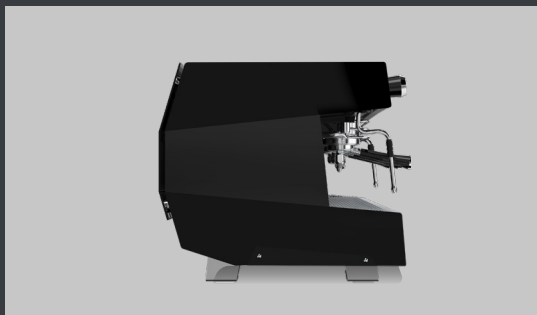

ICON - 3 GRUPPI

MAKE YOUR COFFEE ICONIC Icon è una macchina affidabile in grado di produrre un espresso eccellente e ripetibile nel tempo, la risposta a ciò di cui necessitano business con picchi di lavoro in ore di punta, per fornire risultati impeccabili con il minimo sforzo.

AFFIDATI AL DC SYSTEM Le tecnologie DC system GCS, MCS e OCS rendono Icon una candidata ideale per il canale Horeca, dove alti tassi di turnover e frequenti richieste durante la giornata possono mettere a dura prova la qualità in tazza.

YOUR BRAND, YOUR ICON Linee leggere e tagli geometrici per i pannelli laterali, formati da un unico guscio di acciaio inossidabile. Per il pannello posteriore, invece, ampio spazio alla vocazione custom, grazie a un ampio range di colori RAL e alla possibilità di utilizzare materiali speciali su misura.

dimensioni (l x h x p)	940x510x525 mm
peso	95 kg
consumo di energia (24h-stand-by)	6,3 kW (5,5kW200-220V3)
potenza massima	380/400V3N +T 50/60 Hz - 220/230 V, 50/60 Hz - 200/220 V, 3 50/60 Hz
carico connesso	13 l
capacità della caldaia	0,5 l
capacità dei gruppi indipendenti	opzionale
GCS Grinder Control System	opzionale
MCS Milk Control System	opzionale

DALLA
CORTE

ICON

ICON - 3 GRUPPI



DYNAMIC BLACK

1-MC-ICON-3-DB-400

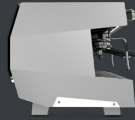

DYNAMIC WHITE

1-MC-ICON-3-DW-400



DYNAMIC RED

1-MC-ICON-2-DR-400



DYNAMIC GREY

1-MC-ICON-3-DG-400



BLACK WALNUT

1-MC-ICON-3-BN-400

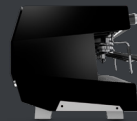

TOTAL MATT BLACK

1-MC-ICON-3-TMB-400



WHITE OAK

1-MC-ICON-3-WO-400



ADJUSTABLE FEET
(optional)



DOUBLE
MCS



DC SYSTEM

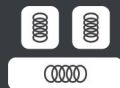

MULTIBOILER



COOL TOUCH
(optional)



ENERGY
SAVING



CUSTOM
COLOURS



CUSTOM
MATERIALS



58mm FILTER
(optional)



CARBON
NEUTRAL



ICON HV - 2 GRUPPI

MAKE YOUR COFFEE ICONIC Icon è una macchina affidabile in grado di produrre un espresso eccellente e ripetibile nel tempo, la risposta a ciò di cui necessitano business con picchi di lavoro in ore di punta, per fornire risultati impeccabili con il minimo sforzo.

AFFIDATI AL DC SYSTEM Le tecnologie DC system GCS, MCS e OCS rendono Icon una candidata ideale per il canale Horeca, dove alti tassi di turnover e frequenti richieste durante la giornata possono mettere a dura prova la qualità in tazza.

YOUR BRAND, YOUR ICON Linee leggere e tagli geometrici per i pannelli laterali, formati da un unico guscio di acciaio inossidabile. Per il pannello posteriore, invece, ampio spazio alla vocazione custom, grazie a un ampio range di colori RAL e alla possibilità di utilizzare materiali speciali su misura.

dimensioni (l x h x p)	720X603X555 mm
peso	84 kg
consumo di energia (24h-stand-by)	4,5 kW
potenza massima	380/400V 3N +T 50/60 Hz - 220/230 V, 50/60 Hz - 220/230 3+T 50/60 Hz
carico connesso	8 l
capacità della caldaia	0,5 l
capacità dei gruppi indipendenti	opzionale
GCS Grinder Control System	opzionale
MCS Milk Control System	opzionale

ICON HV - 2 GRUPPI



DYNAMIC BLACK
1-MC-ICON-2-DB-400

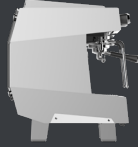

DYNAMIC WHITE
1-MC-ICON-2-DW-400



DYNAMIC RED
1-MC-ICON-2-DR-400

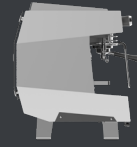

DYNAMIC GREY
1-MC-ICON-2-DG-400



BLACK WALNUT
1-MC-ICON-2-BN-400



TOTAL MATT BLACK
1-MC-ICON-2-TMB-400



WHITE OAK
1-MC-ICON-2-WO-400



ADJUSTABLE FEET
(optional)



DOUBLE
MCS



DC SYSTEM

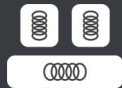

MULTIBOILER



COOL TOUCH
(optional)



ENERGY
SAVING



CUSTOM
COLOURS



CUSTOM
MATERIALS



58mm FILTER
(optional)



CO₂
CARBON
NEUTRAL



ICON HV - 3 GRUPPI

MAKE YOUR COFFEE ICONIC Icon è una macchina affidabile in grado di produrre un espresso eccellente e ripetibile nel tempo, la risposta a ciò di cui necessitano business con picchi di lavoro in ore di punta, per fornire risultati impeccabili con il minimo sforzo.

AFFIDATI AL DC SYSTEM Le tecnologie DC system GCS, MCS e OCS rendono Icon una candidata ideale per il canale Horeca, dove alti tassi di turnover e frequenti richieste durante la giornata possono mettere a dura prova la qualità in tazza.

YOUR BRAND, YOUR ICON Linee leggere e tagli geometrici per i pannelli laterali, formati da un unico guscio di acciaio inossidabile. Per il pannello posteriore, invece, ampio spazio alla vocazione custom, grazie a un ampio range di colori RAL e alla possibilità di utilizzare materiali speciali su misura.

dimensioni (L x h x p)	930x603x555 mm
peso	101 kg
consumo di energia (24h-stand-by)	6,3 kW
potenza massima	380/400V 3N +T 50/60 Hz - 220/230 V, 50/60 Hz - 220/230 3+T 50/60 Hz
carico connesso	13 l
capacità della caldaia	0,5 l
capacità dei gruppi indipendenti	opzionale
GCS Grinder Control System	opzionale
MCS Milk Control System	opzionale

ICON HV- 3 GRUPPI



DYNAMIC BLACK
1-MC-ICON-3-DB-400

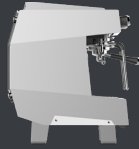

DYNAMIC WHITE
1-MC-ICON-3-DW-400

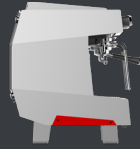

DYNAMIC RED
1-MC-ICON-2-DR-400

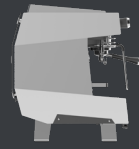

DYNAMIC GREY
1-MC-ICON-3-DG-400



BLACK WALNUT
1-MC-ICON-3-BN-400



TOTAL MATT BLACK
1-MC-ICON-3-TMB-400



WHITE OAK
1-MC-ICON-3-WO-400



ADJUSTABLE FEET
(optional)



DOUBLE
MCS



DC SYSTEM

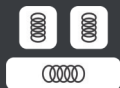

MULTIBOILER



COOL TOUCH
(optional)



ENERGY
SAVING



CUSTOM
COLOURS



CUSTOM
MATERIALS



58mm FILTER
(optional)



CARBON
NEUTRAL