

ICON - 2 GROUPS

MAKE YOUR COFFEE ICONIC Icon is a reliable espresso machine that can make an excellent and consistent espresso over time, the answer to what businesses need during their busiest hours to provide impeccable results with minimum effort.

RELY ON THE DC SYSTEM The technologies of the DC system GCS, MCS and OCS, make Icon an ideal candidate for the Horeca market, where high turnover rates and frequent peak times during the day can really put quality to the test.

YOUR BRAND, YOUR ICON. Light lines and geometric cuts for the side panels formed by a single stainless-steel shell. On the back panel there's plenty of room for custom projects, thanks to a wide range of RAL colorations and special custom materials.

dimensions (w x h x d)	730x510x525 mm
weight	77 kg
max power	4,5 kW [3,9kW 200-220V3]
connected load	380/400V3N +T 50/60 Hz - 220/230 V, 50/60 Hz - 200/220 V, 3 50/60 Hz
boiler capacity	8 l
group head capacity	0,5 l
GCS Grinder Control System	optional
MCS Milk Control System	optional
OCS Online Control System	optional

Version 115 also available

ICON - 2 GROUPS

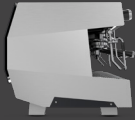

DYNAMIC BLACK

1-MC-ICON-2-DB-400

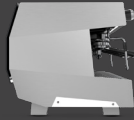

DYNAMIC WHITE

1-MC-ICON-2-DW-400



DYNAMIC RED

1-MC-ICON-2-DR-400



DYNAMIC GREY

1-MC-ICON-2-DG-400



BLACK WALNUT

1-MC-ICON-2-BN-400

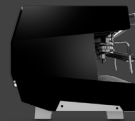

TOTAL MATT BLACK

1-MC-ICON-2-TMB-400



WHITE OAK

1-MC-ICON-2-WO-400



ADJUSTABLE FEET
(optional)



DOUBLE
MCS



DC SYSTEM

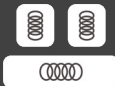

MULTIBOILER



COOL TOUCH
(optional)



ENERGY
SAVING



CUSTOM
COLOURS



CUSTOM
MATERIALS



58mm FILTER
(optional)



CO₂
CARBON
NEUTRAL

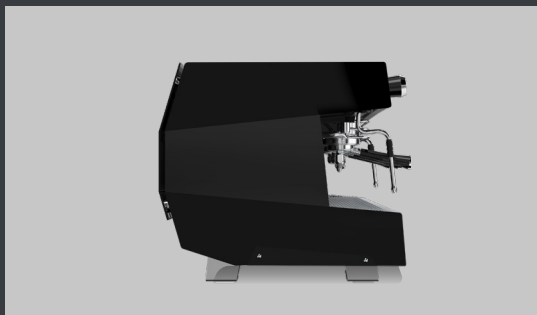

ICON - 3 GROUPS

MAKE YOUR COFFEE ICONIC Icon is a reliable espresso machine that can make an excellent and consistent espresso over time, the answer to what businesses need during their busiest hours to provide impeccable results with minimum effort.

RELY ON THE DC SYSTEM The technologies of the DC system GCS, MCS and OCS, make Icon an ideal candidate for the Horeca market, where high turnover rates and frequent peak times during the day can really put quality to the test.

YOUR BRAND, YOUR ICON. Light lines and geometric cuts for the side panels formed by a single stainless-steel shell. On the back panel there's plenty of room for custom projects, thanks to a wide range of RAL colorations and special custom materials.

dimensions (w x h x d)	940x510x525 mm
weight	95 kg
max power	6,3 kW [5,5kW200-220V3]
connected load	380/400V3N +T 50/60 Hz - 220/230 V, 50/60 Hz - 200/220 V, 3 50/60 Hz
boiler capacity	13 l
group head capacity	0,5 l
GCS Grinder Control System	optional
MCS Milk Control System	optional
OCS Online Control System	optional

Version 115 also available

ICON - 3 GROUPS



DYNAMIC BLACK

1-MC-ICON-3-DB-400

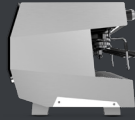

DYNAMIC WHITE

1-MC-ICON-3-DW-400



DYNAMIC RED

1-MC-ICON-3-DR-400



DYNAMIC GREY

1-MC-ICON-3-DG-400



BLACK WALNUT

1-MC-ICON-3-BN-400

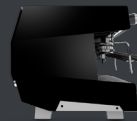

TOTAL MATT BLACK

1-MC-ICON-3-TMB-400



WHITE OAK

1-MC-ICON-3-WO-400



ADJUSTABLE FEET
(optional)



DOUBLE
MCS



DC SYSTEM

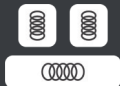

MULTIBOILER



COOL TOUCH
(optional)



ENERGY
SAVING



CUSTOM
COLOURS



CUSTOM
MATERIALS



58mm FILTER
(optional)



CO₂
CARBON
NEUTRAL



ICON HV - 2 GROUPS

MAKE YOUR COFFEE ICONIC Icon is a reliable espresso machine that can make an excellent and consistent espresso over time, the answer to what businesses need during their busiest hours to provide impeccable results with minimum effort.

RELY ON THE DC SYSTEM The technologies of the DC system GCS, MCS and OCS, make Icon an ideal candidate for the Horeca market, where high turnover rates and frequent peak times during the day can really put quality to the test.

YOUR BRAND, YOUR ICON. Light lines and geometric cuts for the side panels formed by a single stainless-steel shell. On the back panel there's plenty of room for custom projects, thanks to a wide range of RAL colorations and special custom materials.

dimensions (w x h x d)	720X603X555 mm
weight	84 kg
max power	4,5 kW
connected load	380/400V 3N +T 50/60 Hz - 220/230 V, 50/60 Hz - 220/230 3+T 50/60 Hz
boiler capacity	8 l
group head capacity	0,5 l
GCS Grinder Control System	optional
MCS Milk Control System	optional

ICON HV - 2 GROUPS



DYNAMIC BLACK

1-MC-ICON-2-DB-400

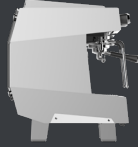

DYNAMIC WHITE

1-MC-ICON-2-DW-400

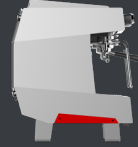

DYNAMIC RED

1-MC-ICON-2-DR-400

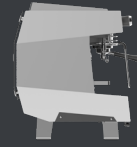

DYNAMIC GREY

1-MC-ICON-2-DG-400



BLACK WALNUT

1-MC-ICON-2-BN-400



TOTAL MATT BLACK

1-MC-ICON-2-TMB-400



WHITE OAK

1-MC-ICON-2-WO-400



ADJUSTABLE FEET
(optional)



DOUBLE
MCS



DC SYSTEM

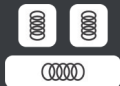

MULTIBOILER



COOL TOUCH
(optional)



ENERGY
SAVING



CUSTOM
COLOURS



CUSTOM
MATERIALS



58mm FILTER
(optional)



CARBON
NEUTRAL



ICON HV - 3 GROUPS

MAKE YOUR COFFEE ICONIC Icon is a reliable espresso machine that can make an excellent and consistent espresso over time, the answer to what businesses need during their busiest hours to provide impeccable results with minimum effort.

RELY ON THE DC SYSTEM The technologies of the DC system GCS, MCS and OCS, make Icon an ideal candidate for the Horeca market, where high turnover rates and frequent peak times during the day can really put quality to the test.

YOUR BRAND, YOUR ICON. Light lines and geometric cuts for the side panels formed by a single stainless-steel shell. On the back panel there's plenty of room for custom projects, thanks to a wide range of RAL colorations and special custom materials.

dimensions (w x h x d)	930x603x555 mm
weight	101 kg
max power	6,3 kW
connected load	380/400V 3N +T 50/60 Hz - 220/230 V, 50/60 Hz - 220/230 3+T 50/60 Hz
boiler capacity	13 l
group head capacity	0,5 l
GCS Grinder Control System	optional
MCS Milk Control System	optional

ICON HV - 3 GROUPS



DYNAMIC BLACK
1-MC-ICON-3-DB-400

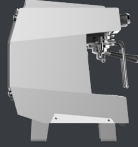

DYNAMIC WHITE
1-MC-ICON-3-DW-400



DYNAMIC RED
1-MC-ICON-3-DR-400

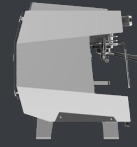

DYNAMIC GREY
1-MC-ICON-3-DG-400



BLACK WALNUT
1-MC-ICON-3-BN-400



TOTAL MATT BLACK
1-MC-ICON-3-TMB-400

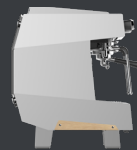

WHITE OAK
1-MC-ICON-3-WO-400



ADJUSTABLE FEET
(optional)



DOUBLE
MCS



DC SYSTEM

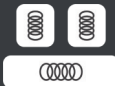

MULTIBOILER



COOL TOUCH
(optional)



ENERGY
SAVING



CUSTOM
COLOURS



CUSTOM
MATERIALS



58mm FILTER
(optional)



CARBON
NEUTRAL